

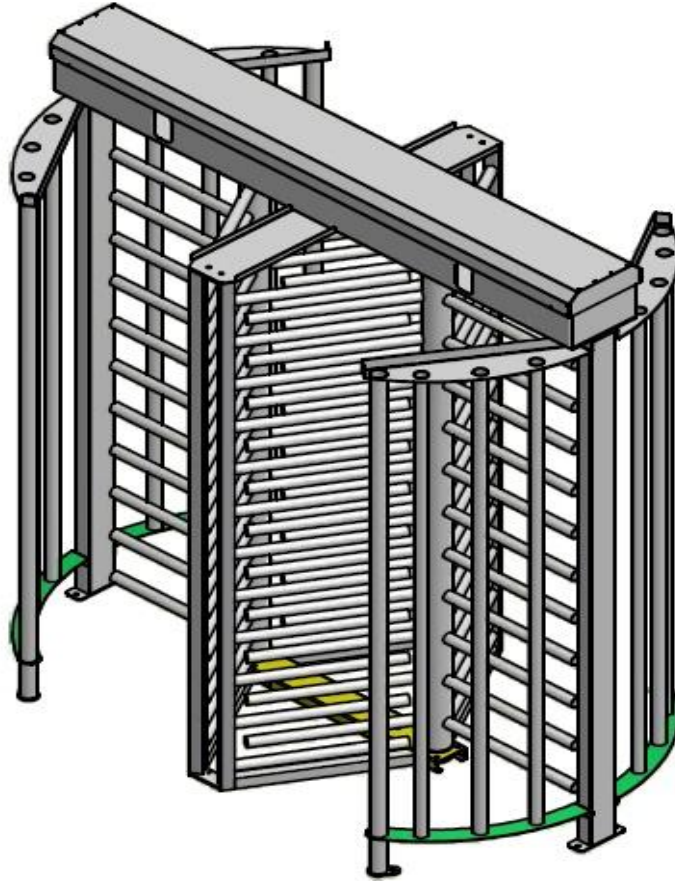

## TURNSTILES



# T2500D DOUBLE TRIPOD ELECTROMECHANICAL TURNSTILE OPERATION AND MAINTENANCE MANUAL

Version V1.00

2013 – ANKARA

**MAKIM reserves the right to make changes at any time at this document, related product and product group without any notice. All rights reserved.**

## CONTENTS

<b>BEFORE YOU START .....</b>	<b>HATA! YER İŞARETİ TANIMLANMAMIŞ.</b>
<b>1. TURNSTILE SAFETY INSTRUCTIONS.....</b>	<b>3</b>
<b>2. TURNSTILE USAGE INSTRUCTIONS.....</b>	<b>HATA! YER İŞARETİ TANIMLANMAMIŞ.</b>
<b>3. T2500 D DOUBLE TRIPOD TURNSTILE TECHNICAL SPECIFICATIONS.....</b>	<b>4</b>
<b>4. TRIPOD TURNSTILE MOUNTING INSTRUCTIONS .....</b>	<b>5</b>
<b>5. TRIPOD TURNSTILE MAINTENANCE INSTRUCTIONS .....</b>	<b>6</b>
<b>6.TURSTILE MOUNTING .....</b>	<b>6</b>
<b>7. PASS/STOP INDICATION BOARD .....</b>	<b>7</b>
<b>8. POWER SUPPLY AND SAFETY INSTRUCTIONS.....</b>	<b>7</b>
<b>8.1-POWER SUPPLY .....</b>	<b>7</b>
<b>8.2- GÜVENLİK TALİMATI .....</b>	<b>7</b>
<b>9. T2500 D DOUBLE TRIPOD TURNSTILE MAINTENANCE INSTRUCTIONS.....</b>	<b>8-9</b>
<b>10. TURNSTILE TROUBLE SHOOTING.....</b>	<b>10-11</b>
<b>11.SOME OF OUR TURNSTILES MODELS .....</b>	<b>12</b>
<b>12.CERTIFICATES .....</b>	<b>133</b>
<b>12.1 -ISO CERTIFICATE .....</b>	<b>134</b>
<b>12.2-EC DECLARATION OF CONFORMITY.....</b>	<b>145</b>
<b>12.3-WARRANTY CERTIFICATE .....</b>	<b>166</b>

*MANUFACTURER COMPANY*

*GENERAL INFORMATION*



[www.makim.com.tr](http://www.makim.com.tr)

### FABRİKA/FACTORY

Sincan Organize Sanayi Bölgesi  
Erkunt Caddesi No:20, Sincan  
ANKARA/TÜRKİYE  
TEL: (+90.312) 267 56 87  
FAX: (+90.312) 267 56 99  
satis@makim.com.tr

### ŞUBE/BRANCH

Perpa Ticaret Merkezi  
A Blok Kat: 11  
No:1421, Şişli  
İSTANBUL/TÜRKİYE  
TEL: (+90.212) 210 29 41  
FAX: (+90.212) 210 68 15  
sube@makim.com.tr

# BEFORE YOU START

Thank you for purchasing T2500D Double Electro-mechanic Turnstile. Please, carefully read the instructions contained in this manual for a long and smooth operation of the turnstile and keep the manual for future references.



## 1. TURNSTILE SAFETY INSTRUCTIONS

- It is recommended to read all safety and maintenance instructions before installing and using the turnstile.
1. Before operating the turnstile, read the manual.
  2. Do not open the turnstile, due to safety precautions. Any repairment must be done only by authorized services. Modifications made by user may result in danger for the turnstile and people.
  3. Do not operate damaged turnstiles and call an authorized service immediately.
  4. Comply with the power and voltage values specified in the technical specifications of turnstile.
  5. Comply with the operating temperature range specified in the technical specifications.
  6. Check the power supply and control the card connections before re-energizing the turnstile after maintenance or damage.
  7. Use certified spare parts and accessories approved and allowed by the manufacturer.
  8. In case of any problem, cut off the electrical connections of the turnstile and call an authorized service.
  9. During maintenance and cleaning, cut off the power of turnstile. Otherwise, it may cause danger to people.
  10. During cleaning, use wet rag.
  11. Keep the turnstile away from over heated or fire environment. Over heat may cause break in the system. Do not operate the turnstile for long time under direct sun exposure.
  12. Do not use the turnstile in high magnetic areas.
  13. Do not expose the turnstile to excessive water in order to prevent any penetration.

## 2. TURNSTILE USAGE INSTRUCTIONS

1. The turnstile is designed so as to allow one person to pass each time and more than one person should not try to pass at the same time.
2. In case of any malfunctioning, avoid actions that may result in damage to the turnstile.
3. In case of any malfunctioning, take the system in idle state and do not use it in order to avoid further damage to the system.
4. During cleaning, do not use substances harmful to the turnstile.

**The manufacturer will not accept any responsibility for any inquiry or damage resulting from non-compliance with the security and safety instructions indicated above.**

### 3. T2500 D DOUBLE TRIPOD TURNSTILE TECHNICAL SPECIFICATIONS

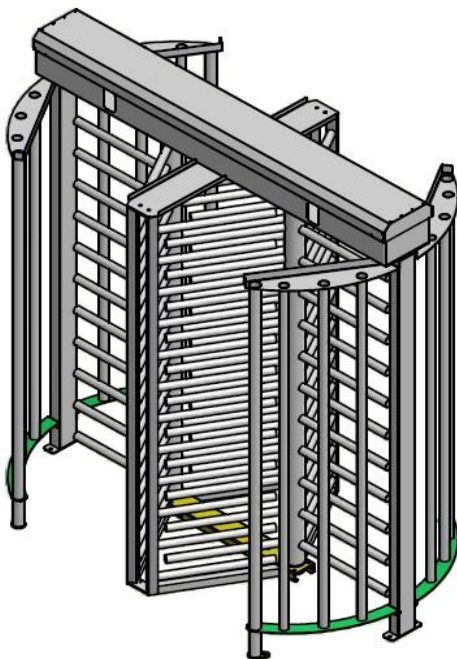
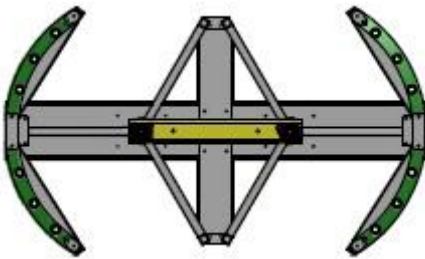
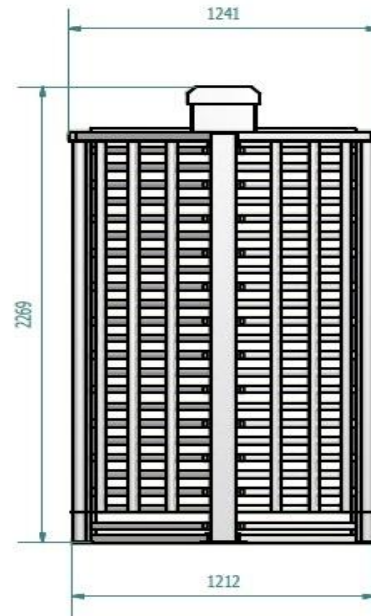
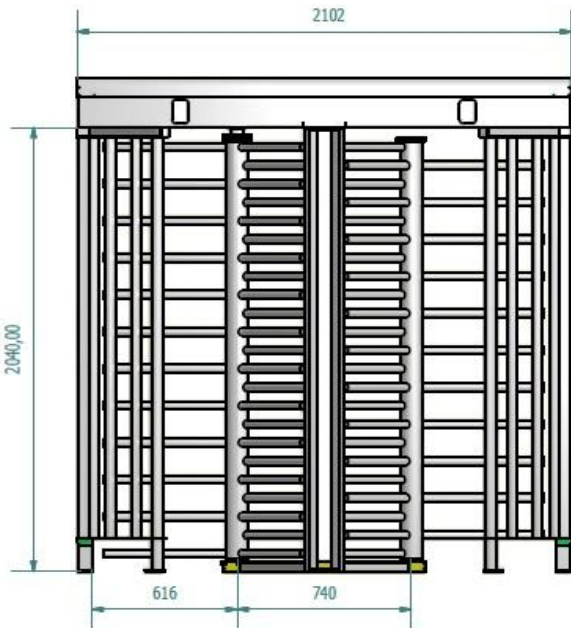

**Power Consumption:** 220V 50Hz / 30 W

**Operation Voltage** : 24 V DC +- %20

**Body Features** : IP42 protection, outer case body and arms are manufactured as powder coated.

**Passing Block** : With controlled tripod arms positioned 120° degrees.

**Direction Control** : Birectional, free control.

**Arms** : Ø40x2mm electroplastic, powder coated pipes profile. It can be manufactured stainless steel pipes as optional.

**Operation Temperature** : - 20 C° - + 70 C°

**Pass/Stop Indicator** : One indicator light on each side ( green arrow/red cross )

**Dimensions**

(widthxlenght xheight):2080x1270x2239mm.

**Weight** : 550 kg

### 4. T2500D DOUBLE TURNSTILE MOUNTING INSTRUCTIONS

1. Select a proper location so as not to obstruct turnstile's operation.
2. Check the structure of the ground of installation site to ensure the necessary stability requirements.
3. Mark the hole places on the ground in which the turnstile will be mounted.
4. Drill the marked mounting holes by Q10 drill bit and clean the dust inside the hole by the help of the air.
5. Fix the steel anchors to the drilled holes. If the ground is not strong, fix the steel anchors using chemical soil mixture (recommended one is Hilti HIT HY 150 ).Wait 20 minutes for hardening of chemical soil mixture.
6. Pass the power and data cables which are prepared before, through the hole on mounting plate.
7. Place the mounting plate on the steel anchors and after putting the washer and nuts, fix the to the ground.
8. After placing the turnstile on the fixed mounting frames, screw the bolts connecting turnstile and mounting plate to each other.
9. See the picture below about mounting of turnstile and anchor to the ground.

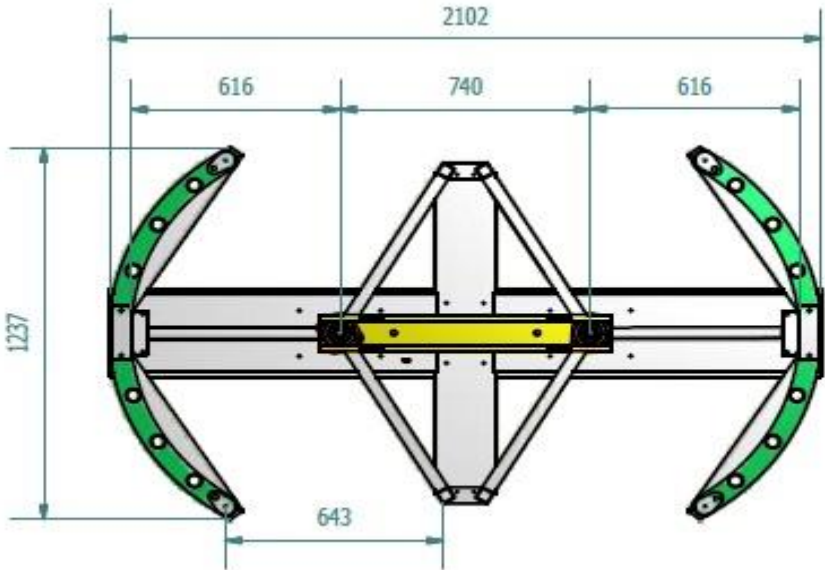
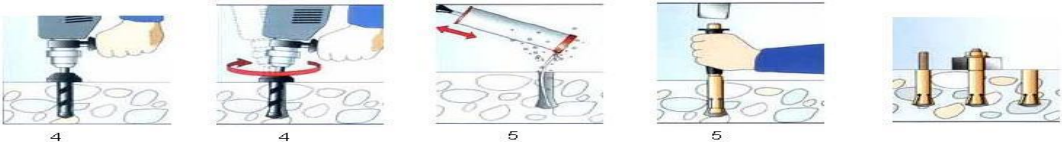

MATERIAL LIST FOR T2500D DOUBLE

A	B	C	D
M12. STEEL ANCHOR	M12 WASHER	M8 NUT	M8 WASHER
12 PIECES	12 PIECES	12 PIECES	12 PIECES

## 5.TURNSTILE MAINTENANCE INSTRUCTIONS

The maintenance instructions and times are identified in order to be general informations . We suggest to the users, users should determine the maintenance instructions as related to using conditions, climate conditions and environment conditions.

1. The dust of the turnstile case should be removed with a moisturized rag
2. Export connecting screws should be controlled in each 3 months as observing.

Turnstiles periodic maintenance must be performed by qualified service personnel. If needed contact with the producer to provide information about periodic maintenance.

## 6.TURNSTILE MOUNTING

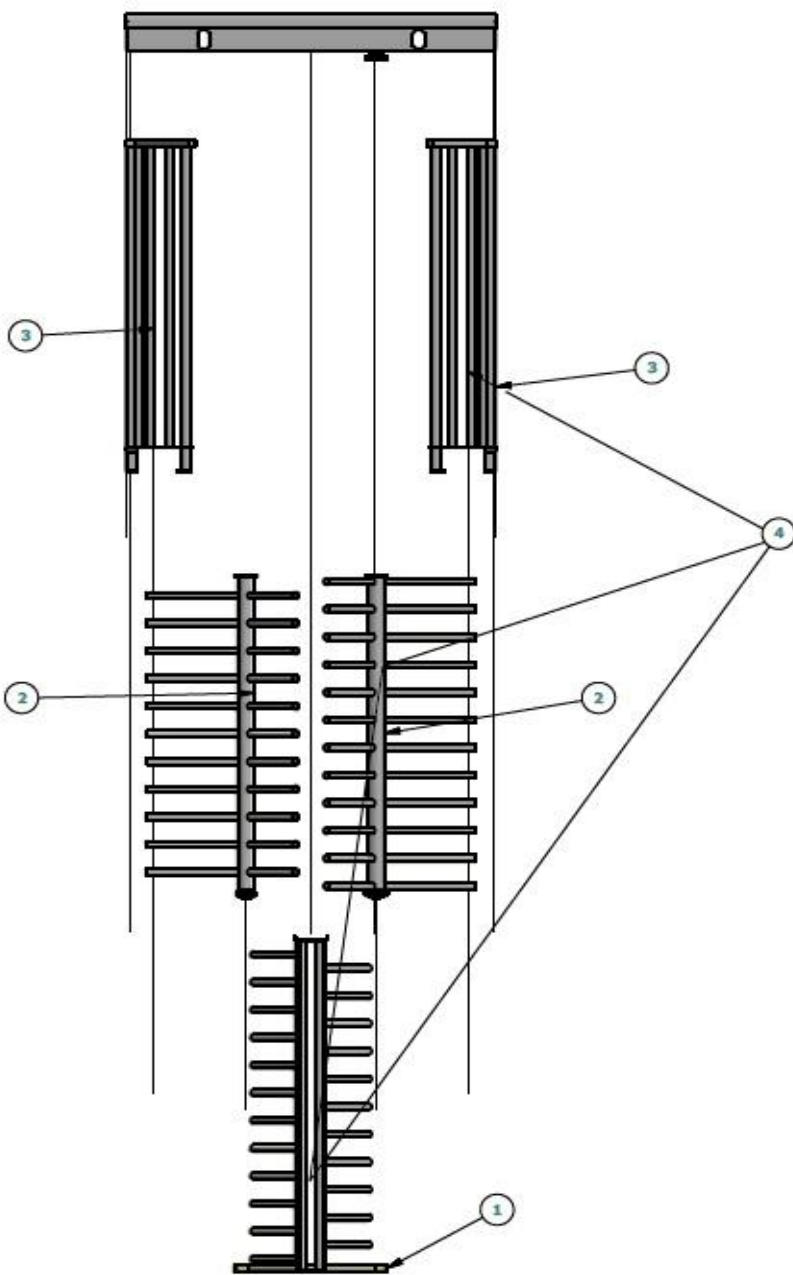

- 1) 1 number part is mounted to the ground.
- 2) 2 number parts are placed as placing to the holes on the 1 number part.
- 3) Top cover is mounted on the 3 number parts.
- 4) Mounted top cover is mounted to 1 number part's top part.

## 7. PASS/STOP INDICATOR BOARD

There are green arrow and red cross lights created by LED on both sides of turnstile. It is provided as standard on the turnstile. It works with 24V DC. When the tip of control signal system is left empty, it indicated red cross, and when there is 24V energy, it indicated green arrow.

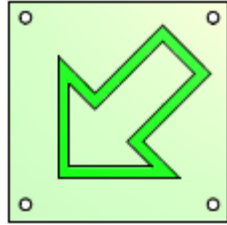

**GREEN ARROW: OPEN FOR ACCESS**

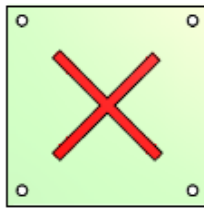

**RED CROSS: CLOSED TO ACCESS.**

### **THAT PASS/STOP INDICATOR BOARD SPARE PART LIST;**

1-A00B1027 - BM29E INDICATOR BOARD GROUP

2-A00B1122 – INDICATOR MICA (90x70 BM29E) PLEXY

## 8. POWER SUPPLY AND SAFETY INSTRUCTIONS

### 8.1-POWER SUPPLY:

The control equipment on turnstile and electronic control unit are supplied by 24V DC, SMP'S Power Supply. Power supply is chosen in a way to supply enough power for existing hardware only.



### 8.2-SAFETY INSTRUCTIONS

1. Never remove the protection cover on the power supply.
2. Take notice of the warnings on protection cover and power supply, and the values of power and braker while doing and operation.
3. On the tag of power supply, the connection tips are shown. Stick to those signs on the power supply while making connections.

**NOTE: NEVER SUPPLY THE EXTERIOR DEVICES FROM TURNSTILE BOARD OR POWER SUPPLY. MANUFACTURER COMPANY DOES NOT ACCEPT ANY RESPONSIBILITY FOR THE FAILURE RESULTING FROM THIS FAULT**

## 9.T2500 D DOUBLE TRIPOD TURNSTILE MAINTENANCE INSTRUCTIONS

The maintenance tips and times given in this part are general informations. It is suggested to the user to decide maintenance instructios himself depending on environmental and usage conditions. Turnstile must have maintenance by authorized service periodically. In case it is not possible to connect with an authorized dealer, get into contact with manufacturer company and obtain information on periodical maintenance.

<b>T2500D DOUBLE TRIPOD ELECTROMECHANICAL TURNSTILE</b>	<b>TIME</b>	<b>OPERATION</b>	<b>EXPLANATION</b>
<b>General</b>			
Turnstile External Case	1-4 Weeks	Dusting	Remove the dust with a moisturized rag. Impurities on turnstile surface are cleaned with stainless steel care spre, Würth brand.
Tripod bevel drice connection screw	6 months	Control	Screw tightness is checked. Be sure that the navel washer is in it's place. In case of need, a bevel drice connection screw is glued with Loctite 66 againts to loosening.
Turnstile Arm Cover Taps	6 months	Control	Worn or fallen tapsa re changed with new ones.
Anchors and nuts connected to the ground	12 months	Control	Control the nuts and anchors for ground connection. Replace the impaired connections.
<b>Turnstile Mechanism</b>			
Selenoids (Solenoid, Solenoid Lever Arm and Locking Bar)	12 months	Control Cleaning	Observe the movements of solenoid plungers and its connected parts ( solenoid lever arm and locking bar ) both manually and in powered mode. Check the solenoid plunger. If there is shrink or impaction, replace the solenoid group with new one. The solenoids for entry and exit directions are different from eachother. When necessary, use WD40 spre to oil solenoid plungers, to incese lubricity. (Turnstile is shipped from factory, with solenoid plungers oiled with WD40 spre.)
Locking Bar	12 months	Control	Strongly force the locking function to turn when the turnstile arm is locked. If there is any miss, check replace with new one.
TmekF the control cam and the spring	12 months	Control	Tripod arms are turned for 1 tour to entrance and exit, and springs operations is controled as observing. If after the tripod arms passed 60° degree, it's turning is not completed and it is not been the next position, cam and connection springs are controlled because of squeezing and locking. If it need, it is changed with a new one.



TmekF ratchet ring pawl and ratchet spring	12 months	Control	<p>Tripod arms are turned for 1 tour to entrance and exit, and spring ratchet operation is controlled as observing.</p> <p>After the tripod arm passes 30° degree as turning to the access direction, arm is controlled as pulling in the opposite direction. If the arm is going to opposite direction, ratchet and spring connection places about the arm are controlled because of squeezing and locking. If it need, it is changed with a new one.</p>
Linear Hydraulic Shock Absorber	12 months	Control	<p>To control this part, rotate the turnstile arm once. If the arm stops smoothly and quietly, and there is no crash, it means damper functions normal. If the rotation cannot be completed or completed with crash, first check the damper setting , if still not functions well, replace with new one. Also, this part should be configured in summer and winter because of heat differences. The screw behind the damper is taken to 1,5-2 position in summer, and to 2-3 position in winter. If damper setting is not done properly, other mechanism parts will worn out easily and will need to be replaced ( locking bars,tubes etc. ).</p>
Mechanism Connection Cables	12 months	Control	<p>Control the cables coming from selenoid and microswitches ( by looking only ). And check the tightness and connections of Mega radar 10 clip screws.</p>
Central Control Equipments and Rotation Parts	12 months	Control Oiling	<p>Rotate the mechanism once, and observe the rotation parts ( central control element tubes) and operation surfaces. Check the problematic parts and replace if necessary. If there is no problem with functions, oil the tubes and operating parts with WD40 spray and complete the maintenance. (Turnstile is shipped from factory, with these parts oiled with WD40 spray)</p>
<b>Electornic Equipment and Cabling</b>			
Electronic Boards And Cabling	12 months	Control Cleaning	<p>Check the connectors of passing cables between boards and from boards to turnstile. Turnikeye geçiş verilerek turnikenin çalışması gözlemlenir. If there is not any problem with turnstile operating, it means systems is functioning properly. If any problem is observed, replace the boards with new ones.</p> <p>Note: For cleaning, Würth brand oxide cleaner is suggested.</p>
System operating control and maintenance			<p>Validator and electronic parts' functioning, operating and detailed control&amp;maintenance informations are checked through validator and turnstile electronic equipment documents.</p>

## 10.TURNSTILE TROUBLE SHOOTING



FAULT IDENTIFICATION	REASONS	SOLUTION OFFERS
Although the power is on,the arms cannot be locked,LED displays are turned off, and there is no function in turnstile.	<ol style="list-style-type: none"> <li>1. Electricity may not be received.</li> <li>2. Power supply may be broken or fuse may have blown.</li> </ol>	<ol style="list-style-type: none"> <li>1. Check the power cables. Check the fuse and thermics.</li> <li>2. Check the power supply.</li> </ol>
After a passage is completed, turnstile is not locked and it allows other passes.	<ol style="list-style-type: none"> <li>1. Selenoid and Locking Parts</li> <li>2. Direction sensor and microswitches</li> <li>3. Cabling and Electronic Equipments</li> </ol>	<ol style="list-style-type: none"> <li>1. Check the cable connections about selenoid and locking parts</li> <li>2. Check the microswitches and related cable connections.</li> <li>3. Check the electronic equipment functions.</li> </ol>
Although indicators and buzzer work normal,turnstile does not allow passage.	<ol style="list-style-type: none"> <li>1. Pressed stop button.</li> <li>2. Selenoid and locking parts.</li> <li>3. Electronic board equipments.</li> </ol>	<ol style="list-style-type: none"> <li>1. Check the stop button and related cabling.</li> <li>4. Check the cable connections about selenoid and locking parts</li> <li>2. Check the electronic equipment functions.</li> </ol>
Power is on, but arms rotate free.	<ol style="list-style-type: none"> <li>1. Pressed Emergecny Button or Free Passage Button.</li> <li>2. Selenoid and locking parts.</li> <li>3. Electronic Board Equipments</li> </ol>	<ol style="list-style-type: none"> <li>1. Check the cabling about emergency button and free pass button.</li> <li>5. Check the cable connections about selenoid and locking parts</li> <li>2. Check the electronic equipment functions.</li> </ol>
Turnstile does not send the info of passage although the rotation is completed.	<ol style="list-style-type: none"> <li>4. Direction sensor and microswitches</li> <li>1. Electronic Board Equipments</li> </ol>	<ol style="list-style-type: none"> <li>1. Check the cable connections about microswitches. Check the data cables.</li> <li>2. Check the electronic equipment functions.</li> </ol>
Turnstile arms make voice or shuffle while rotating.	<ol style="list-style-type: none"> <li>1. Central control element and rotation parts may have been very dirty or failed totally.</li> </ol>	<ol style="list-style-type: none"> <li>1. Clean the central control element and rotating parts' working surfaces. And oil with WD40 spreya and provide disk rotation.</li> </ol>

In winter or summer, turnstile does not stop with same smoothness.	1. Necessity to re-configure damper settings depending on seasonal heat changes.	The setting screw behind the damper is taken to 1,5-2 position in summer, and to 2-3 position in winter to provide smooth stop.
Geçiş yaptıktan sonra kollar çapraz kalıyor ve dönüşü tamamlayıp başlangıç konumuna gelmiyor.	1. Centering cam on the mechanism 2. Hydraulic shock absorber or its springs	1. Check the centering cam and spring. Connect if there is any removed tip, and replace necessary parts. 2. Check the hydraulic damper, fix it to appropriate mode or replace it.
Although passage approval is given,turnstile does not allow pass.	1. Pressed stop button. 2. Solenoid and locking parts. 3. Electronic equipments and cabling. 4. Validator ( card reader,remote control,fingerprint reader etc ) or cable connections.	1. Check the stop button and related cabling. 3. Check the cable connections about solenoid and locking parts 4. Check the electronic equipment functions. 5. Check the validator function.
Turnstile constantly allows free pass to one direction.	1. Solenoid and locking parts.	6. Check the cable connections about solenoid and locking parts 1. Sticking or any similar problem is solved.

## 10.SOME OF OUR TURNSTILES MODELS



T230 MOTORLU VIP



T450

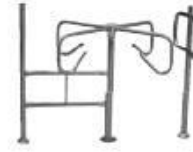

T-MT 4



T250



T80



T250 S



T700 MOTORLU SWG



T345

# 12.CERTIFICATE

## 12.1 -ISO CERTIFICATE

**ABS Quality Evaluations**

**CERTIFICATE OF CONFORMANCE**  
This is to certify that the Quality Management System of:

**MAKIM MAKINA TEKNOLOJILERI SAN. TIC. A.S**  
ASO 1 Organize  
Erkunt Cad No: 20 Sincan  
Ankara  
Turkey

has been assessed by ABS Quality Evaluations, Inc. and found to be in conformance with the requirements set forth by:

**ISO 9001:2008**  
The Quality Management System is applicable to:

**DESIGN AND MANUFACTURE OF ELECTRIC DISCHARGE MACHINES - ACCESS CONTROL SYSTEMS -  
ELECTROMECHANICAL SYSTEMS EQUIPMENTS AND PARTS - INVESTMENT CASTED PARTS**

Certificate No:	33674
Original Certification Date:	18 December 2002
Effective Date:	01 November 2010
Expiration Date:	17 December 2011
Issue Date:	01 November 2010

  
\_\_\_\_\_  
Alex Weissberg, President

Validity of this certificate is based on periodic audits of the management system defined by the above scope and is contingent upon prompt, written notification to ABS Quality Evaluations, Inc. of significant changes to the management system or components thereof.

ABS Quality Evaluations, Inc. 16823 Northchase Drive, Houston, TX 77060, U.S.A.  
Validity of this certificate may be confirmed at [www.abs-qe.com/enr\\_validation](http://www.abs-qe.com/enr_validation)

  
MGMT. SYS.  
RvA C 048



Copyright 2010 ABS Quality Evaluations, Inc. All rights reserved.

Printed on: 11/09/10 10:57:32 AM

## 12.2-EC DECLARATION OF CONFORMITY

# EC DECLARATION OF CONFORMITY

MAKİM MAKİNA TEKNOLOJİLERİ SAN. VE TİC. A.Ş.  
Sincan OSB Erkunt Cad. No:20 Sincan/ANKARA  
Tel: +90-(312) 267 56 87 Faks: +90-(312) 267 56 99  
E-mail: info@makim.com.tr-satis@makim.com.tr  
Web: www.makim.com.tr

We, Makim Makine Teknolojileri San. Ve Tic. A.Ş., declare under our sole responsibility that the product,

<b>Machine Name</b>	Tripod Turnstile
<b>Machine Model</b>	T200,T240, T250, T250 S, T250 A, T281,T300, T300 MI, T345, T450.T210
<b>Production Tape</b>	2011

to which this declaration relates is in conformity with the following standards and other normative documents

- **TS EN 1050** safety of machinery-Principles for risk assesment
- **TS EN 12100-1** Safety of Machinery-Basic Concepts General Principles for Design Part 1: Basic Terminology, Methodology
- **TS EN 12100-2** Safety Of Machinery-Basic Concepts General Principles Fors Design, Part 2: Technical Principles And Specifications
- **TS EN 953** safety Of Machinery-Guards-General requirements for the design and construction of fixed and guards
- **TS EN 294** safety of machinery-Safety distances to prevent danger zones being reached by the upper limbs
- **TS EN 981** safety of machinery-
- **TS EN 954-1** Safety of machinery –Safety-related parts of control systems-Part 1: General principles dor design.
- **TS EN 1037** safety of machinery-Prevention of unexpected start-up
- **TS EN 61000-6-2** Electromagnetic compatibility (EMC)-Part 6-2: Generic standarts- Immunity for industrial environments
- **TS EN 61000-6-4** Electromagnetic compatibility (EMC)-Part 6-4: Generic standarts-Emission standarts for industrial environments
- **TS 3033 EN 60529** Degrees of protection provided by enclosures (IP code) (for electrical equipments)
- **EN 60204-1** Safety of machinery- Electrical equipment of machines-Part 1: General requirements and following the provision of
- **98/37/AT** Machinery (98/37/EC)
- **73/23/AT** Low voltage equipment (73/23/EEC,93/68/EEC)
- **93/68/EC** Electromagnetic compability (89/336/EEC;92/31/EEC;93/68/EEC) (98/13/EEC) Directives.

Date-Place 23.03.2011-ANKARA

Name Tacettin İLERİ  
General Manager

Signature



# EC DECLARATION OF CONFORMITY

MAKİM MAKİNA TEKNOLOJİLERİ SAN. VE TİC. A.Ş.  
Sincan OSB Erkunt Cad. No:20 Sincan/ANKARA  
Tel: +90-(312) 267 56 87 Faks: +90-(312) 267 56 99  
E-mail: info@makim.com.tr-satis@makim.com.tr  
Web: www.makim.com.tr

We, Makim Makine Teknolojileri San. Ve Tic. A.Ş., declare under our sole responsibility that the product,

<b>Machine Name</b>	Full Height Turnstile
<b>Machine Model</b>	T2500 B, T2500 D, T2500 K
<b>Production Tape</b>	2011

to which this declaration relates is in conformity with the following standards and other normative documents



- **TS EN 1050** safety of machinery-Principles for risk assesment
- **TS EN 12100-1** Safety of Machinery-Basic Concepts General Principles for Design Part 1: Basic Terminology, Methodology
- **TS EN 12100-2** Safety Of Machinery-Basic Concepts General Principles Fors Design, Part 2: Technical Principles And Specifications
- **TS EN 953** safety Of Machinery-Guards-General requirements for the design and construction of fixed and guards
- **TS EN 294** safety of machinery-Safety distances to prevent danger zones being reached by the upper limbs
- **TS EN 981** safety of machinery-
- **TS EN 954-1** Safety of machinery –Safety-related parts of control systems-Part 1: General principles dor design.
- **TS EN 1037** safety of machinery-Prevention of unexpected start-up
- **TS EN 61000-6-2** Electromagnetic compatibility (EMC)-Part 6-2: Generic standarts- Immunity for industrial environments
- **TS EN 61000-6-4** Electromagnetic compatibility (EMC)-Part 6-4: Generic standarts-Emission standarts for industrial environments
- **TS 3033 EN 60529** Degrees of protection provided by enclosures (IP code) (for electrical equipments)
- **EN 60204-1** Safety of machinery- Electrical equipment of machines-Part 1: General requirements and following the provision of
- **98/37/AT** Machinery (98/37/EC)
- **73/23/AT** Low voltage equipment (73/23/EEC,93/68/EEC)
- **93/68/EC** Electromagnetic compability (89/336/EEC;92/31/EEC;93/68/EEC) (98/13/EEC) Directives.

Date-Place 03.01.2011-ANKARA

Name Tacettin İLERİ  
General Manager

Signature

## 12.3-WARRANTY CERTIFICATE

	<b>T.C. SANAYİ VE TİCARET BAKANLIĞI</b>	
	<b>TÜKETİCİNİN VE REKABETİN KORUNMASI GENEL MÜDÜRLÜĞÜ</b>	
	<b>GARANTİ BELGESİ</b>	
Belgenin Veriliş Tarihi ve Sayısı:	11.03.2009-66597	
Belgenin Geçerlilik Tarihi:	11.03.2011	
Bu belgenin kullanılmasında; 4077 sayılı Tüketicinin Korunması Hakkında Kanun ve bu Kanuna dayanılarak yürürlüğe konulan Garanti Belgesi Uygulama Esaslarına Dair Yönetmelik uyarınca, T.C. Sanayi ve Ticaret Bakanlığı Tüketicinin ve Rekabetin Korunması Genel Müdürlüğü tarafından izin verilmiştir.		
<b>İmalatçı ve İthalatçı Firmanın</b>		
Ünvanı:	MAKİM MAKİNA TEKNOLOJİLERİ SANAYİ VE TİCARET A.Ş.	
Merkez Adresi:	SİNCAN OSB UYGURLAR CAD.NO:2 ANKARA	
Telefonu:		
Telefaksı:		
<b>Malın</b>		
Cinsi:	TURNİKELİ (BARİYERLİ) GEÇİŞ SİSTEMİ	
Markası:	MAKİM	
Modeli:	-	
Bandrol ve Seri No:	--	
Teslim Tarihi ve Yeri:	-	
Garanti Suresi:	2 Yıl	
Azami Tamir Suresi:	30İş Günü	
<b>Satıcı Firmanın</b>		
Ünvanı:		
Adresi:		
Telefonu:		
Telefaksı:		
Fatura Tarihi ve No:	---	
		Sezer TURHAN Bakan a. GEN.MÜDÜR YARD.
		
Belgenin Doğruluğu <a href="http://www.sanayi.gov.tr">www.sanayi.gov.tr</a> Adresinden Kontrol Edilebilir.		